







Causa costi di gestione, agli ordini inferiori al valore di 100,00 euro di sola merce, verrà addebitato un costo di 14,00 euro. Ordini di importo inferiori a 50,00 euro addebito pari a 19,00 euro. / For orders value less than 100,00 euro (transport cost excluded), 14,00 euro as extra costs charges, and 19,00 euro for orders value less than 50,00 euro (leftover stock deliveries excluded).

NS. COD. CODE	COMPATIBILE COMPATIBLE	DESCRIZIONE DESCRIPTION	DIM. EST mm EXT SIZE mm	IMMAGINE IMAGE	
02330	Zanussi	Perno con molla <i>Spring shaft</i>			
02316	Angelo Po Sagi	Cerniera superiore Dx per 650 - 1400 lt modello vecchio <i>Upper right hinge for 650 - 1400 lt old model</i>			
02317	Angelo Po Sagi	Cerniera superiore Sx per 650 - 1400 lt modello vecchio <i>Upper left hinge for 650 - 1400 lt old model</i>			
02310	Angelo Po 36G6520 Sagi Electrolux Alpeninox 081653 082219 Polaris 1412050	Cerniera perno lungo per armadi Intercambiabile DS o SN Long shaft hinge for cabinets <i>Interchangeable left or right</i>			
02311	Alpeninox Electrolux Dexion Everlasting Mareno Cold Line Afinox - MBM	Cerniera perno corto per armadi Mareno SF - EF - AF/M (dimensioni come 02310) Intercambiabile DS o SN Short shaft hinge for cabinets Mareno SF - EF - AF/M (dimensions: see code 02310) <i>Interchangeable left or right</i>			
02313	Icematic Polaris	Cerniera mod. pivot 175 con perno a croce intercambiabile destra o sinistra <i>Pivot hinge 175 crios cross pin interchangeable left or right</i>			
02312	Angelo Po Desmon Mondial Elite	Cerniera mod. pivot 176 carré perno quadro 8 mm intercambiabile dx o sx <i>Pivot hinge 176 carré with square pin 8 mm interchangeable left or right</i>			

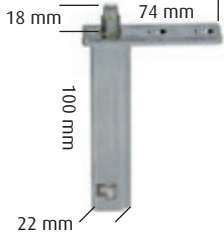
Causa costi di gestione, agli ordini inferiori al valore di 100,00 euro di sola merce, verrà addebitato un costo di 14,00 euro. Ordini di importo inferiori a 50,00 euro addebito pari a 19,00 euro. / For orders value less than 100,00 euro (transport cost excluded), 14,00 euro as extra costs charges, and 19,00 euro for orders value less than 50,00 euro (leftover stock deliveries excluded).

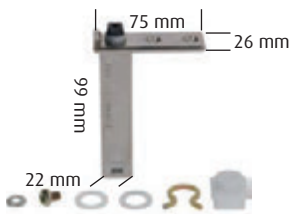
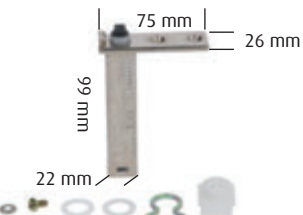
NS. COD. CODE	COMPATIBILE COMPATIBLE	DESCRIZIONE DESCRIPTION	DIM. EST mm EXT SIZE mm	IMMAGINE IMAGE
02340		Cerniera mod. 910 con rampa per porte medio/grandi a tampone - verniciata, intercambiabilità Dx/Sx cerniera con due corpi bassi <i>Hinge mod. 910 with ramp for medium/big doors overlapping - painted, right/left interchangeability hinge with two slim bodies</i>		 
02341		Cerniera mod. 915 senza rampa per porte medio/grandi a tampone - verniciata, intercambiabilità Dx/Sx cerniera con due corpi bassi <i>Hinge mod. 915 without ramp for medium/big overlapping doors - painted, right/left interchangeability hinge with two slim bodies</i>		
02342		Cerniera mod. 920 con rampa e molla per porte medio/grandi a tampone - verniciata, intercambiabilità Dx/Sx cerniera con due corpi bassi <i>Hinge mod. 920 with ramp and spring for medium/big overlapping doors - painted, right/left interchangeability hinge with two slim bodies</i>		
02343		Cerniera mod. 930 con rampa per porte medio/grandi a tampone - verniciata, intercambiabilità Dx/Sx cerniera con un corpo basso e un corpo alto <i>Hinge mod. 930 with ramp for medium/big overlapping doors - painted, right/left interchangeability hinge with one slim and one big body</i>		
02344		Cerniera mod. 935 senza rampa per porte medio/grandi a tampone - verniciata, intercambiabilità Dx/Sx cerniera con un corpo basso e un corpo alto <i>Hinge mod. 935 without ramp for medium/big overlapping doors - painted, right/left interchangeability hinge with one slim and one big body</i>		

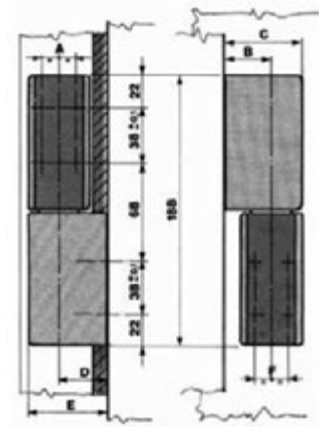

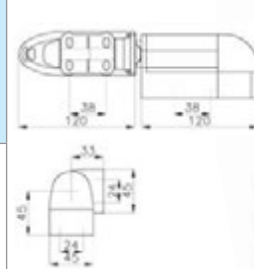

LE CERNIERE DI QUESTA SERIE SONO STATE REALIZZATE CON 3 DIVERSI TIPI DI CORPI: BASSO (B), MEDIO (M), ALTO (A), IN MODO DA POTER REALIZZARE DIVERSE CONFIGURAZIONI IN QUANTO QUESTI CORPI SONO UTILIZZATI INDIFFERENTEMENTE COME CORPO FISSO E/O CORPO MOBILE

THE HINGES OF THIS SERIES ARE AVAILABLE WITH THREE DIFFERENT TYPE OF BODIES: LOW (B), MEDIUM LOW (MB), MEDIUM HIGH (MA), ALL WITH VERTICAL ADJUSTMENT

MODELLO MODEL	dimensioni mm / size mm						configurazione corpo body configuration		peso weight	battuta mm stop mm	
	corpo mobile / mobile body			corpo fisso / fixed body			mobile	fisso fixed		gr	da
	A	B	C	D	E	F					
910 - 915 - 920	24	33	55	33	55	24	B	B	500/520	55	66
930 - 935 - 940	24	33	55	55	77	24	B	A	570/590	77	110

NS. COD. CODE	COMPATIBILE COMPATIBLE	DESCRIZIONE DESCRIPTION	DIM. EST mm EXT SIZE mm	IMMAGINE IMAGE
02333	MTH	Cerniera reversibile H = 55 <i>Reversible hinge H = 55</i>		 
02336	MTH	Cerniera reversibile H = 45 <i>Reversible hinge H = 45</i>		

Causa costi di gestione, agli ordini inferiori al valore di 100,00 euro di sola merce, verrà addebitato un costo di 14,00 euro. Ordini di importo inferiori a 50,00 euro addebito pari a 19,00 euro. / For orders value less than 100,00 euro (transport cost excluded), 14,00 euro as extra costs charges, and 19,00 euro for orders value less than 50,00 euro (leftover stock deliveries excluded).

NS. COD. CODE	COMPATIBILE COMPATIBLE	DESCRIZIONE DESCRIPTION	DIM. EST mm EXT SIZE mm	IMMAGINE IMAGE	
02359		Cerniera serie 2800 mod. 2830 con rampa per porte battuta da 65 a 90 mm, in materiale composito ad elevata resistenza alle basse temperature ed alla corrosione, regolazione: orizzontale / verticale / profondità, perno antisfilamento e fissaggio inaccessibile a porta chiusa, rampa nascosta autolubrificante, reversibilità Dx/Sx <i>Hinge series 2800 model 2830 with ramp for door thickness 65 to 90 mm, made of composite material highly resistant to low temperatures and corrosion, adjustment: horizontal/ vertical/ depth, security pin and fixing inaccessible with door closed, concealed self-lubricating ramp, RH/LH interchangeable</i>			
02360		Spessore per battuta 1 pezzo per battute da 75 a 110 mm 2 pezzo per battute da 85 a 130 mm <i>Shim for thickness 1 piece for thicknesses 75 to 110 mm 2 pieces for thicknesses 85 to 130 mm</i>			
02372		Cerniera cromata lucida in zama mod. 4245L boccole e tappi in nylon sporgenza superiore a 33 mm <i>Polished chrome-plated hinge made of Zamak mod. 4245L bushes and plugs made of nylon projection more than 33 mm</i>			
02373		Cerniera con rampa in zama mod. 4260V a movimento ascendente verniciata componenti rampa in nylon sporgenza superiore a 50 mm intercambiabilità Dx/Sx <i>Hinge with ramp made of Zamak mod. 4260V with ascending movement, painted ramp components made of nylon projection more than 50 mm RH/ LH interchangeability</i>			
02374		Cerniera cromata in zama mod. 4269C con boccole in nylon sporgenza superiore a 35 mm <i>Chrome-plated hinge made of Zamak mod. 4269C with nylon bushes projection more than 35 mm</i>			

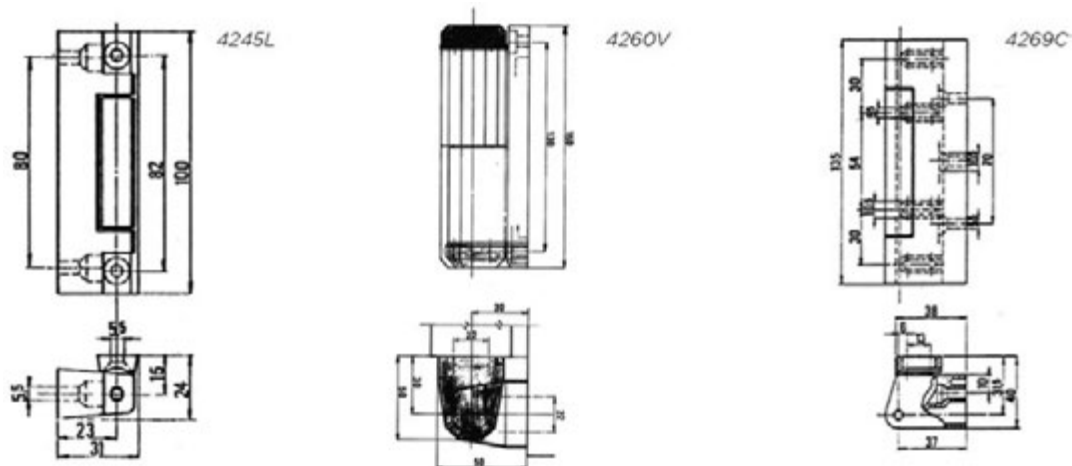

NS. COD. CODE	COMPATIBILE COMPATIBLE	DESCRIZIONE DESCRIPTION	DIM. EST mm EXT SIZE mm	IMMAGINE IMAGE	
02410	Isa Polaris Surfrigo	Molla Dx a torsione per cerniera sinistra, filo 2,4 x 19 spire (per armadi porta a vetro Isa, Polaris e tutti i modelli Surfrigo "Antelao") <i>Right torsion spring for left hinge, wire 2.4 x 19 coils (for cabinets with glass door Isa, Polaris and all Surfrigo "Antelao" models)</i>	14 x 132		
02411	Isa Polaris Surfrigo	Molla Sx a torsione per cerniera sinistra filo 2,4 x 19 spire (per armadi porta a vetro Isa, Polaris e tutti i modelli Surfrigo "Antelao") <i>Right torsion spring for left hinge wire 2.4 x 19 coils (for cabinets with glass door Isa, Polaris and for all Surfrigo "Antelao" models)</i>	14 x 132	